



2013-2014

SHANGHAI HOUSING



014
ISO9001:2000
Registration No. 0505045

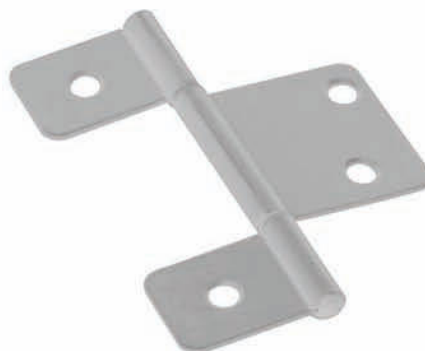

INTRODUCTION INTRODUCTION



014
ISO9001:2000
Registration No. 0505045

SHANGHAI HOUSING

Shanghai Housing is striving to offer our customers the best quality hardware, plastic, die-casting and wooden products at the very competitive prices. A wide range of hardware products are available for your selection.

We are a specialist housing products manufacturer in China. Our products range from all kinds of hinges, handles, nails, screws, drawer slides, brackets, bolts to catches etc. The products details and products finishes are shown in the catalogue. OEM projects are also welcome, just show us your samples and specifications and we can manufacture the products to your requirements.

We have our own STAMPING, ELECTRO-PLATING and ASSEMBLING factories in Shanghai, China, which is the biggest STEEL BASE in China, occupying an area of 8,000 square meters with very advanced machineries.

We implement modern management system to production, sales and marketing services. Also we employ strict QC system so as to maintain highest product quality & reduce products cost, that is why we can supply our customers high-quality hardware products with very competitive prices for the competitive markets.

Our main worldwide markets are: USA, CANADA, EUROPE & ASIA etc, we are now seeking more business partners worldwide. Don't hesitate to contact us for a profitable future. Your enquiries, big or small, will be replied within 24 hours.



UKAS QUALITY MANAGEMENT

CONTENTS

COMMERCIAL DOOR HINGE	商铰	P3
SPRING HINGE	弹簧铰	P3
RESIDENTIAL TYPE HINGE	普通门铰	P4-5
HINGE & SAFETY HASP	铰链和搭扣	P6
MAGNETIC CATCH	磁吸	P7
BI-FOLD DOOR HARDWARE	移门五金	P8
HEAVY BI-FOLD DOOR HARDWARE	重移门五金	P9
PADLOCK & DISC PADLOCKS	挂锁和圆盘锁	P10
LOCK CYLINDER & RECTANGULAR LOCKS	锁芯和矩形锁	P11
DOOR VIEWERS & BOLT	窥视镜和插销	P12
CHAIN GUARD, DOOR GUARD & DOOR STOPS	防盗链, 防盗扣和门碰	P13
SHELF & ROD SUPPORT / TRIANGLE BRACKET	支架	P14
STEEL ADJUSTABLE CLOSET ROD	壁管	P14
SCREW	螺丝	P15
HINGE PIN STYLES	铰芯	P16

FINISHES

AB	ANTIQUE BRASS	US5	青古铜
AC	ANTIQUE COPPER	AC	滚镀红古铜
PB	POLISHED BRASS PLATED	US3	仿金
BB	BRIGHT BRASS	US3-4	光亮铜
PC	CHROME PLATED	US26	亮铬
BN	BLACK NICKEL	US15A	黑镍
SC	SATIN CHROME	US26D	哑铬
SN	SATIN NICKEL	US15	哑镍
DB	DULL BRASS	US4	哑铜
ZP	ZINC PLATED	US2C	白锌
YZ	YELLOW ZINC	US2D	彩黄锌
RB	DULL BRONZE	US10	红铜
AC	ANTIQUE BRONZE LACQUERED	US10A	红古铜(漆, 黑纹)
ORB	ANTIQUE BRONZE OILED	US10B	红古铜(油, 褐纹)
BL	BLACK PRIME LACQUERED	USP-BL	黑漆
WP	WHITE LACQUERED	USP-W	白漆
USP-BP	BLACK POWDER COATED	USP-BP	黑塑
USP-WP	WHITE POWDER COATED	USP-WP	白塑
US32D	BRUSHED STAINLESS STEEL	US32D	不锈钢抛砂
US32	POLISHED STAINLESS STEEL	US32	不锈钢镜面抛光

SHANGHAI HOUSING

RM. 211, NO. 82, BUILDING #6, LANE 1288, WANGYUAN NAN ROAD, FENGXIAN DISTRICT
SHANGHAI, CHINA

TEL: 86-21-67182037 FAX: 86-21-67182937

EMAIL: kf@hardwareshanghai.com www.hardwareshanghai.com

FINISHES



SHANGHAI HOUSING

RM. 211, NO. 82, BUILDING #6, LANE 1288, WANGYUAN NAN ROAD, FENGXIAN DISTRICT
SHANGHAI, CHINA

TEL:86-21-67182037 FAX: 86-21-67182937

EMAIL: kf@hardwareshanghai.com www.hardwareshanghai.com



014
ISO9001:2000
Registration No. 0505045

COMMERCIAL DOOR HINGE SPRING HINGE



S2000

Commercial Door Hinge
3.5" x 3.5" x 3.1mm



S2000-2BB

Commercial Door Hinge
3.5" x 3.5" x 3.1mm-2BB



S4000

Commercial Door Hinge
4" x 4" x 3.3mm



S4055-2BB

Commercial Door Hinge
4" x 4" x 3.3mm-2BB



S47

Commercial Door Hinge
4.5" x 4" x 3.4mm



S47-2BB

Commercial Door Hinge
4.5" x 4" x 3.4mm-2BB



S4500

Commercial Door Hinge
4.5" x 4.5" x 3.4mm



S4500-2BB

Commercial Door Hinge
4.5" x 4.5" x 3.4mm-2BB



S4600-4BB

Commercial Door Hinge
4.5" x 4.5" x 4.5mm-4BB



T4055

Spring Hinge
4" x 4" x 2.7mm



T4500

Spring Hinge
4.5" x 4.5" x 3.4mm



T2055

Commercial Door Hinge
3.5" x 3.5" x 2.7mm

SHANGHAI HOUSING

RM. 211, NO. 82, BUILDING #6, LANE 1288, WANGYUAN NAN ROAD, FENGXIAN DISTRICT
SHANGHAI, CHINA

TEL:86-21-67182037 FAX: 86-21-67182937

EMAIL: kf@hardwareshanghai.com www.hardwareshanghai.com

RESIDENTIAL DOOR HINGE



M0100

Residential Door Hinge
3" x 3" x 2.0mm-SQ
3" x 3" x 1.6mm-SQ



M0122

Residential Door Hinge
3" x 3" x 2.0mm-1/4R
3" x 3" x 1.6mm-1/4R



M0155

Residential Door Hinge
3" x 3" x 2.0mm-5/8R
3" x 3" x 1.6mm-5/8R



M2000

Residential Door Hinge
3.5" x 3.5" x 2.2mm-SQ



M2022

Residential Door Hinge
3.5" x 3.5" x 2.2mm-1/4R



M2055

Residential Door Hinge
3.5" x 3.5" x 2.2mm-5/8R



M4000

Residential Door Hinge
4" x 4" x 2.5mm-SQ
4" x 4" x 2.2mm-SQ



M4022

Residential Door Hinge
4" x 4" x 2.5mm-1/4R
4" x 4" x 2.2mm-1/4R



M4055

Residential Door Hinge
4" x 4" x 2.5mm-5/8R
4" x 4" x 2.2mm-5/8R



M0155-2BB

Residential Door Hinge
3" x 3" x 2.0mm-2BB-5/8R



M2055-2BB

Residential Door Hinge
3.5" x 3.5" x 2.2mm-2BB-5/8R



M4055-2BB

Residential Door Hinge
4" x 4" x 2.5mm-2BB-5/8R

SHANGHAI HOUSING

RM. 211, NO. 82, BUILDING #6, LANE 1288, WANGYUAN NAN ROAD, FENGXIAN DISTRICT
SHANGHAI, CHINA

TEL:86-21-67182037 FAX: 86-21-67182937

EMAIL: kf@hardwareshanghai.com www.hardwareshanghai.com

RESIDENTIAL DOOR HINGE

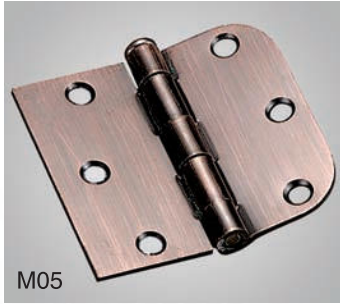

M05
Residential Door Hinge
3" x 3-3/16" x 2.0mm-SQ x 5/8R



M33
Residential Door Hinge
3.5" x 3-3/4" x 2.2mm-SQ x 5/8R



M45
Residential Door Hinge
4" x 4.08" x 2.5mm-SQ x 5/8R



HJ81
Residential Door Hinge
2" x 2" x 1.4mm,
2.5" x 2.5" x 1.8mm



DJ01
Butterfly Non-Mortise Hinge
3.5" x 1.8mm



TS05
Lift-off Hinge
80 x 80 x 2.5mm



M0155-C
Residential Door Hinge
3" x 3" x 2.0mm-Ball Tip



M2055-E
Residential Door Hinge
3.5" x 3.5" x 2.2mm-Steeple Tip



M4100-D
Residential Door Hinge
4" x 4" x 2.5mm-Pagoda Tip



4M27
Residential Door Hinge
4" x 4" x 2.5mm-2BB



M61
Residential Door Hinge with
Safety Pin
4" x 4" x 2.5mm-SQ x 5/8R



4M39
Residential Door Hinge
4" x 4" x 2.5mm-5/8R x SQ

SHANGHAI HOUSING

RM. 211, NO. 82, BUILDING #6, LANE 1288, WANGYUAN NAN ROAD, FENGXIAN DISTRICT
SHANGHAI, CHINA

TEL:86-21-67182037 FAX: 86-21-67182937

EMAIL: kf@hardwareshanghai.com www.hardwareshanghai.com

HINGE AND SAFETY HASP



HJ62

Heavy Narrow Butt Hinge
2-1/2" x 1-5/8"

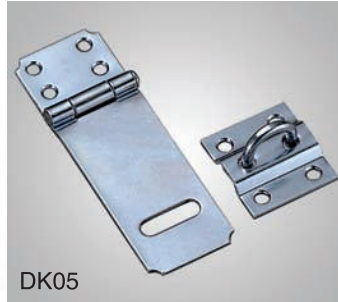

DK05

Safety Hasp Adjustable Staple
1.5", 3.5", 6"

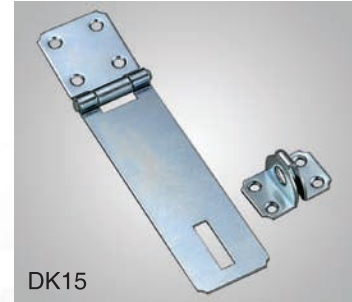

DK15

Heavy Hinge Hasp With Fixed
Staple
2.5", 3.5", 4.5", 6"



M2222

R6.35 Round Corner Narrow Hinge
3.5" x 2-5/16" x 2.1mm-1/4R



M2211

1/2 Round Corner Narrow Hinge
3.5" x 2-5/16" x 2.1mm-1/2R



M2455

G89(R12.7) Round Corner
Narrow Hinge
89 x 57 x 1.6mm-5/8R

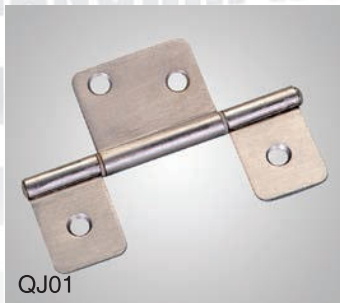

QJ01

Three-Leaf Flag Hinge
3-1/2" x 2-1/2"



HJ05

Heavy Narrow Butt Hinge
1" x 1" x 1.2mm, 1.5" x 1.35" x 1.2mm,
2" x 1.55" x 1.4mm



HJ06

Heavy Narrow Butt Hinge
2.5" x 1.65" x 1.4mm, 3" x 2" x 1.6mm,
3.5" x 2.25" x 1.6mm



PZ42

Flat Non-Mortise Hinge
3" x 1-1/4"



ZM06

Institutional Hinge
2-3/4" x 0.095"



ZM03

Institutional Hinge
2-3/4" x 0.095"

SHANGHAI HOUSING

RM. 211, NO. 82, BUILDING #6, LANE 1288, WANGYUAN NAN ROAD, FENGXIAN DISTRICT
SHANGHAI, CHINA

TEL:86-21-67182037 FAX: 86-21-67182937

EMAIL: kf@hardwareshanghai.com www.hardwareshanghai.com



014
ISO9001:2000
Registration No. 0505045

MAGNETIC CATCH



C004
Double Touch Catch
50mm



C003
Single Touch Catch
22mm



PG
Glass Door Hinge



CX020
Magnetic Catch
42mm



CX040
Magnetic Catch
25mm



PX01
Double-Roll Catch
24mm, 36mm



CX07
Magnetic Catch with One Hole Plate
32mm



CX13
Magnetic Catch
47mm



SBP
Brass Double-Ball
1-11/16", 1-15/16", 2-3/8", 2-3/4"



CX14
Double Magnetic Catch with One Plate
64mm



CX15
Magnetic Catch
35mm



CX16
Double Magnetic Catch with Two Plates(Square)
64mm

SHANGHAI HOUSING

RM. 211, NO. 82, BUILDING #6, LANE 1288, WANGYUAN NAN ROAD, FENGXIAN DISTRICT
SHANGHAI, CHINA

TEL:86-21-67182037 FAX: 86-21-67182937

EMAIL: kf@hardwareshanghai.com www.hardwareshanghai.com

BI-FOLD DOOR HARDWARE

18", 24", 28", 30", 32", 36", 48", 60", 72"



LD
20LB
BI-Fold Door Hardware

18", 24", 28", 30", 32", 36", 48", 60", 72"



HD-1
30LB
BI-Fold Door Hardware

18", 24", 28", 30", 32", 36", 48", 60", 72"



HD-2
30LB
BI-Fold Door Hardware

18", 24", 28", 30", 32", 36", 48", 60", 72"



HD-3
30LB
BI-Fold Door Hardware

SHANGHAI HOUSING

RM. 211, NO. 82, BUILDING #6, LANE 1288, WANGYUAN NAN ROAD, FENGXIAN DISTRICT
SHANGHAI, CHINA

TEL: 86-21-67182037 FAX: 86-21-67182937

EMAIL: kf@hardwareshanghai.com www.hardwareshanghai.com



014
ISO9001:2000
Registration No. 0505045

HEAVY BI-FOLD DOOR HARDWARE

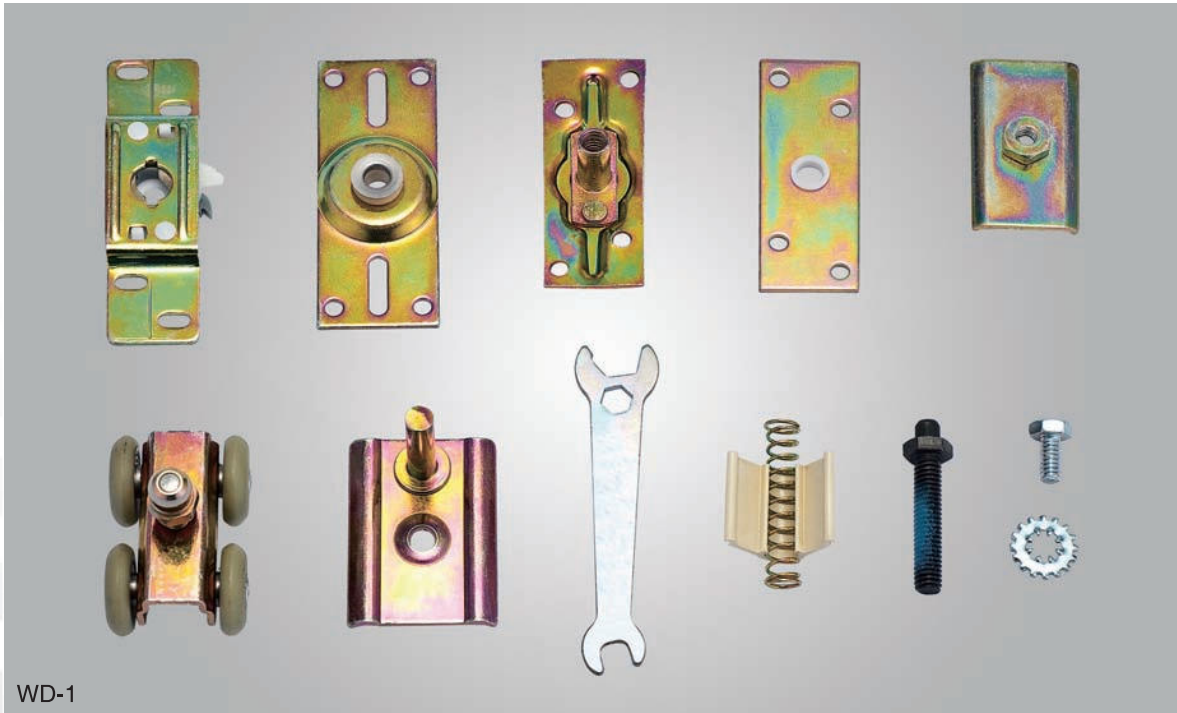

WD-1

125 LB Heavy Bi-Fold Door Hardware

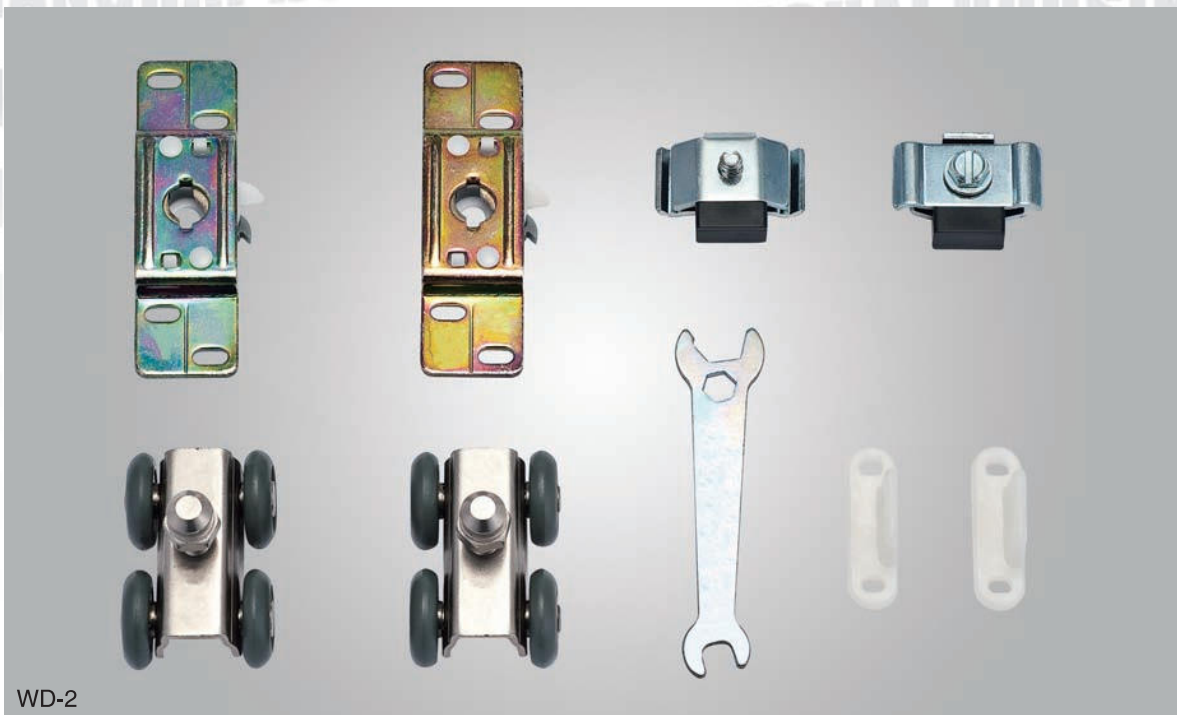

WD-2

250 LB Heavy Bi-Fold Door Hardware

SHANGHAI HOUSING

RM. 211, NO. 82, BUILDING #6, LANE 1288, WANGYUAN NAN ROAD, FENGXIAN DISTRICT
SHANGHAI, CHINA

TEL:86-21-67182037 FAX: 86-21-67182937

EMAIL: kf@hardwareshanghai.com www.hardwareshanghai.com

PADLOCK AND DISC PADLOCKS



G112

Short Shackle Padlock
Medium Shackle Padlock
1-1/2"



G134

Short Shackle Padlock
Medium Shackle Padlock
1-3/4"



G200

Short Shackle Padlock
Medium Shackle Padlock
2"



G212

Short Shackle Padlock
Medium Shackle Padlock
2-1/2"



G34, G100

Padlock
3/4", 1"



G114, G112

Padlock
1-1/4", 1-1/2"



G200, G212

Padlock
2", 2-1/2"



G300

Padlock
3"



YP60

Disc Padlock
60mm



YP70

Disc Padlock
70mm



YP80

Disc Padlock
80mm



YP90

Disc Padlock
90mm

SHANGHAI HOUSING

RM. 211, NO. 82, BUILDING #6, LANE 1288, WANGYUAN NAN ROAD, FENGXIAN DISTRICT
SHANGHAI, CHINA

TEL:86-21-67182037 FAX: 86-21-67182937

EMAIL: kf@hardwareshanghai.com www.hardwareshanghai.com

LOCK CYLINDER AND RECTANGULAR LOCKS



SX-22

Lock Cylinder
ø22 x 27.5 x 17.4mm



SX-60

Lock Cylinder
60mm



SX-70

Lock Cylinder
70mm



SX-80

Lock Cylinder
80mm



SX-90

Lock Cylinder
90mm



Q200

Rectangular Lock
2"



Q300

Rectangular Lock
3"



Q234

Rectangular Lock
2-3/4"



Q314

Rectangular Lock
3-1/4"



Q400

Rectangular Lock
4"



Q84

Rectangular Lock
84mm



Q94

Rectangular Lock
94mm

SHANGHAI HOUSING

RM. 211, NO. 82, BUILDING #6, LANE 1288, WANGYUAN NAN ROAD, FENGXIAN DISTRICT
SHANGHAI, CHINA

TEL:86-21-67182037 FAX: 86-21-67182937

EMAIL: kf@hardwareshanghai.com www.hardwareshanghai.com



014
ISO9001:2000
Registration No. 0505045

DOOR VIEWERS AND BOLT



ML-1

Door Viewer 180°, 1/2" Bore
1-3/8" ~ 2-1/4"



ML-2

Door Viewer 180°, 1/2" Bore
1-3/8" ~ 2-3/8"



ML-3

Door Viewer 180°, 9/16" Bore
1-3/8" ~ 2-1/4"



ML-4

Door Viewer 160°, 1/2" Bore
1-3/8" ~ 2-1/4"



ZXF

Bolt
2", 3", 4", 6", 8", 10", 12", 14",
18", 24"



ZXD

Bolt
3", 4"



ZX-1

Bolt
6"



ZX-2

Bolt
7"



ZX-3

Bolt
6"



ZX-4

Bolt
6"



ZX-5

Bolt
6"



ZX-6

Bolt

SHANGHAI HOUSING

RM. 211, NO. 82, BUILDING #6, LANE 1288, WANGYUAN NAN ROAD, FENGXIAN DISTRICT
SHANGHAI, CHINA

TEL:86-21-67182037 FAX: 86-21-67182937

EMAIL: kf@hardwareshanghai.com www.hardwareshanghai.com



014
ISO9001:2000
Registration No. 0505045

CHAIN DOOR GUARD, SWING DOOR GUARD AND DOOR STOPS



FDL

Chain Door Guard



FDG

Swing Door Guard



DS-1

Door Stops
3-1/8"



DS-2

Door Stops
4"



DS-3

Door Stops



DS-4

Door Stops
4-1/2"



DS-5

Door Stops
3-1/8"



DS-6

Door Stops
3-3/4"



DS-7

Door Stops



DS-8

Door Stops



DS-9

Door Stops



DS-10

Door Stops

SHANGHAI HOUSING

RM. 211, NO. 82, BUILDING #6, LANE 1288, WANGYUAN NAN ROAD, FENGXIAN DISTRICT
SHANGHAI, CHINA

TEL:86-21-67182037 FAX: 86-21-67182937

EMAIL: kf@hardwareshanghai.com www.hardwareshanghai.com



014
ISO9001:2000
Registration No. 0505045

SHELF AND ROD SUPPORT STEEL ADJUSTABLE CLOSET ROD



ZJ30

Shelf Triangle Bracket
3" x 4", 4" x 5", 5" x 6", 6" x 8", 7" x 9",
8" x 10", 10" x 12", 12" x 14"



ZJ26

Deep Triangle Bracket
8" x 10", 10" x 12"



ZJ99

Magnam Bracket
8", 12"



ZJ06

Shelf and Rod Support
12"



ZJ05

Shelf and Rod Support
12"



ZJ03

Shelf and Rod Support
12"



BG-G

Closet Rod with Fix End
18" x 30", 30" x 48", 48" x 72", 72" x 96", 96" x 120", 96" x 150", 120" x 150"



BL

Shower Rods and Flauges
ø25mm (1")

SHANGHAI HOUSING

RM. 211, NO. 82, BUILDING #6, LANE 1288, WANGYUAN NAN ROAD, FENGXIAN DISTRICT
SHANGHAI, CHINA

TEL:86-21-67182037 FAX: 86-21-67182937

EMAIL: kf@hardwareshanghai.com www.hardwareshanghai.com



014
ISO9001:2000
Registration No. 0505045

SCREW

QUALITY SCREWS



THREADS & POINTS

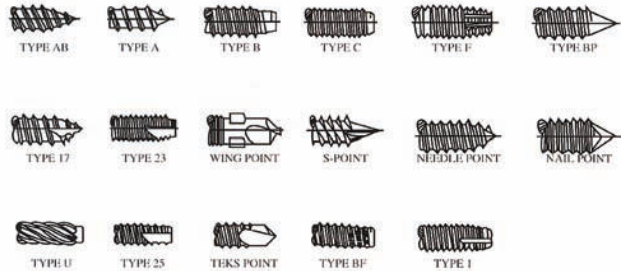

HEAD STYLES

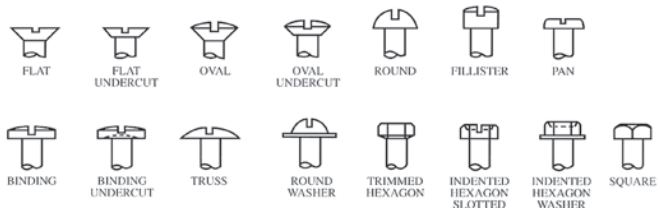

DRIVER STYLES

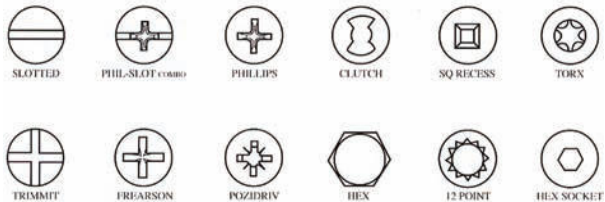





SHANGHAI HOUSING

RM. 211, NO. 82, BUILDING #6, LANE 1288, WANGYUAN NAN ROAD, FENGXIAN DISTRICT
SHANGHAI, CHINA

TEL:86-21-67182037 FAX: 86-21-67182937

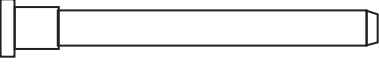
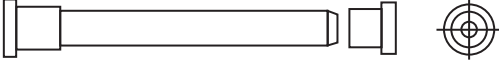
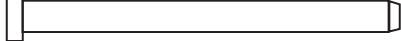
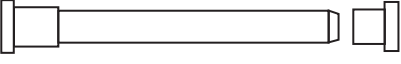
EMAIL: kf@hardwareshanghai.com www.hardwareshanghai.com

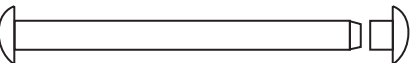
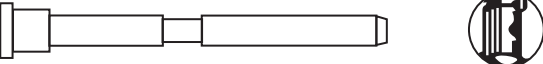
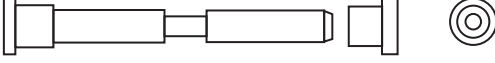
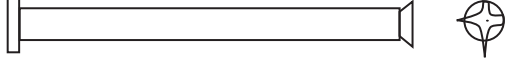
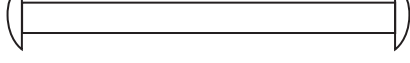
HINGE PIN STYLES

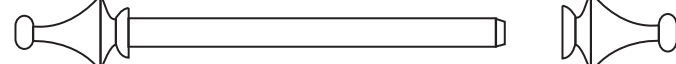
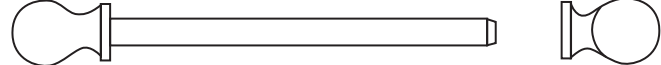
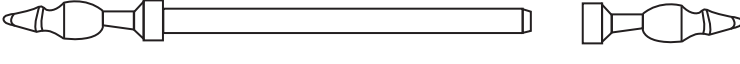
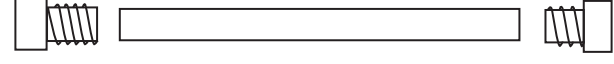
SPECIAL STYLES OF PINS	STYLES	CODE
	Loose Pin	LPT1
	Loose Pin Bottom Button	DP1
	Loose Pin	LPT2
	Loose Pin Bottom Button	DP2
	Fixed Pin Tripartite	DP3
	Loose Pin Double Bottom Oval Tip	DP4
	Optional Removal Pin	NRP1
	Optional Non-Removable Bottom Button	NRP2
	Flat Fixed Pin	FP2
	Round Fixed Pin	FP1
	Steeple Finial Loose Pin	SFP
	Crown Finial Loose Pin	CFP
	Ball Finial Loose Pin	BFP
	Pagoda Finial Loose Pin	PFP
	Flat Tip Loose Pin	FTP

SHANGHAI HOUSING

RM. 211, NO. 82, BUILDING #6, LANE 1288, WANGYUAN NAN ROAD, FENGXIAN DISTRICT
SHANGHAI, CHINA

TEL:86-21-67182037 FAX: 86-21-67182937

EMAIL: kf@hardwareshanghai.com www.hardwareshanghai.com

QUALITY CONTROL



ISO-9001:2000

We have established a strict and mature QC system in our factory, strict inspection and quality control procedures are implemented from raw materials to finished products, so as to assure that our products leaving the factory have the highest quality that will satisfy all our customers requirements.

From July 7, 2005, we have been awarded ISO-9001:2000 by UK Moody International Certification.

Contact us now for a profitable future.

QUALITY CONTROL

Quality is first for Shanghai Housing Products. In order to achieve high product quality, we have invested heavily on testing machineries and tools such as Salt-Fog Testing Machine which is used to test materials and plated layers' antirust capacity from salt and fog in the air, for example: antiacid. We also have Self Closing testing machineries and so on, to guarantee high quality of our products.



SHANGHAI HOUSING

RM. 211, NO. 82, BUILDING #6, LANE 1288, WANGYUAN NAN ROAD, FENGXIAN DISTRICT
SHANGHAI, CHINA

TEL:86-21-67182037 FAX: 86-21-67182937

EMAIL: kf@hardwareshanghai.com www.hardwareshanghai.com

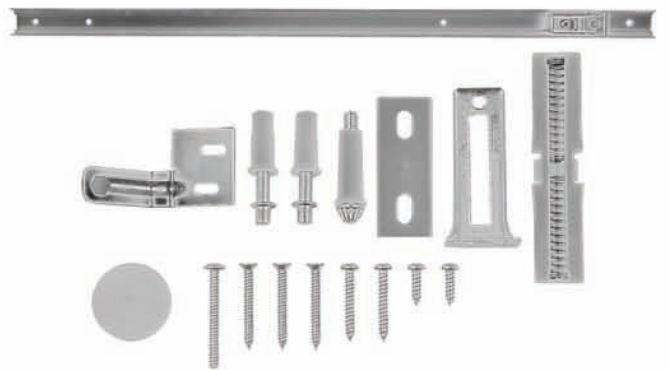
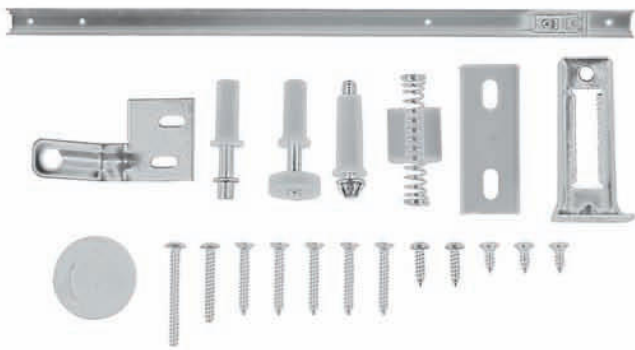
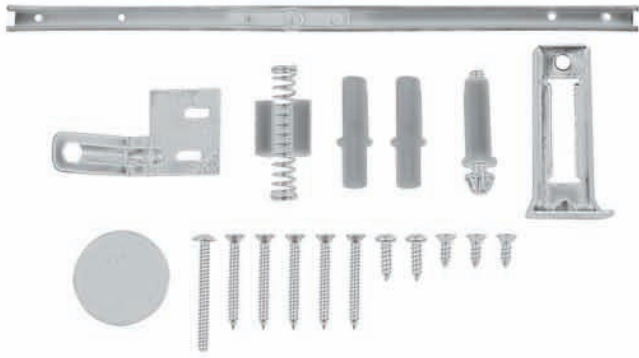

SHANGHAI HOUSING

RM. 211, NO. 82, BUILDING #6, LANE 1288, WANGYUAN NAN ROAD, FENGXIAN DISTRICT
SHANGHAI, CHINA

TEL: 86-21-67182037 FAX: 86-21-67182937

EMAIL: kf@hardwareshanghai.com www.hardwareshanghai.com

